



Laboratory Screw Compressor Enclosure With Air Treatment Center Package (LDRE and LTRE)*

Rev. 09/09/13

GENERAL

The Powerex Laboratory Screw Compressor Enclosure package shall include multiple oil-free rotary screw air compressors modules and associated equipment and an Air Treatment Center Package (shipped separately). Each system is completely tested before shipment and includes:

- Multiple oil-free rotary screw air compressor modules and associated equipment

Air Treatment Center Package includes:

- Corrosion resistant air receiver
- Dual Desiccant air dryers
- Dual filtration system
- Dew point monitor

System installation requirements:

1. Main power to each Compressor Module
2. Single phase 120 volt utility power to the Air Treatment Center control panel
3. For systems with tank mounted separately, wiring of utility power to the tank auto drain from the Air Treatment Center control panel
4. Interconnecting plumbing connections between each compressor and tank/dryer skid

OIL-FREE ROTARY SCREW AIR COMPRESSOR MODULE

The standard assembly includes:

- Patented super rotor screw elements with cooling jackets, flange mounted to gear box with integral oil sump
- Air (or water) cooled intercooler and aftercooler with corrosion resistant centrifugal moisture separators and automatic fail safe drains
- Air intake filter/silencer with replaceable element
- Discharge air check valve and safety relief valve
- Pressure lubrication system with an independent motor driven gear type oil pump, providing pre and post lubrication. Gear box/oil sump breather and spin on oil filter. Air (or water) cooled oil cooler.
- Integral base and frame for compressor and drive assembly
- Full sound attenuating enclosure with removable doors
- Load/unload capacity control valve with blow off valve and muffler
- TEFC flange mounted indication motor
- Electrical enclosure with Wye-Delta motor starter mounted and wired
- Allen Bradley PLC (programmable logic controller) microprocessor
- Touch screen operator interface

Each compressor shall include a discharge check valve, isolation valve, air or water cooled aftercooler, a moisture separator with automatic drain, and a high discharge temperature shut down switch. Isolation valve is shipped loose for field installation.

MOTORS

Each compressor shall be driven by an ODP, NEMA construction motor. Motors are EISA compliant and premium efficient.

COMPRESSOR CONTROL PANEL

Operation of the compressor and display of essential systems is accomplished with an Allen Bradley PLC and the touch screen display for each compressor. This Programmable Logic Controller and display can easily be programmed to meet varying operating requirements.

Description of Features:

- Compressor Status Indication
- Hour Meter
- Alarm Bell
- Pressure Indicators
- Temperature Indicators
- Service Requirement Indicators
- Pre-Alarm Indicators
- Remote Input Commands (optional)
- Compressor Safety Shutdown Indications
- Remote Output Status
- Event alarm log
- Manual load/unload switch
- Connection to DCS (remote monitoring capabilities via customer computer system) (Optional)

The master control panel provides power to the ATC dryer skid, monitors, and tank auto drain. The touch screen control panel on each air compressor module has all the alarm contacts and operations for the compressor modules; the Air Treatment Module control panel has a separate control panel on the Air Treatment Module skid.

OPTIONAL VFD CONTROL PANEL

Each compressor to be equipped with an integrated Allen Bradley VFD motor control to maximize energy efficiency of the compressor under partial load conditions.

*NOTE: LDRE stands for Laboratory Duplex Rotary Screw Enclosure with Air Treatment Center Package, LTRE stands for Laboratory Triplex Rotary Screw Enclosure with Air Treatment Center Package



Laboratory Screw Compressor Enclosure With Air Treatment Center Package (LDRE and LTRE)*

Rev. 09/09/13

AIR RECEIVER

The system shall include an ASME air receiver rated for 200 PSI MAWP. 240 gallon tanks are skid mounted with the Air Treatment Center. 400 gallon and larger tanks are shipped loose and include the same accessories mentioned below. (Accessories may require field installation.) The tank shall be equipped with:

- Sight gauge
- A pressure gauge and a safety relief valve
- 3-valve bypass
- Zero air loss type automatic moisture drain (with manual drain valve back up)

The receiver shall be internally lined for corrosion resistance.

AIR TREATMENT CENTER

The dryer package is a skid mounted design consisting of the receiver tank (if 240 gal. or less; 400 gal. tanks are shipped loose), dual desiccant air dryers, dual filtration system, dew point monitor, a sample port and all bypass piping. All components are mounted and plumbed together. Piping from the compressor outlet to the tank assembly is to be field furnished and installed. Compressed air from the tank assembly is routed to the Air Treatment Center by field provided and installed piping.

DESICCANT AIR DRYERS

The twin-tower, heatless desiccant air dryer shall yield a pressure dew point of -40 degrees F. The dryer shall be installed and plumbed on a common steel skid to the air receiver (400 gallon and larger tanks are mounted separately). The dryer design shall be of the automatic pressure swing, heatless, regenerative type and shall include a purge muffler for quiet operation.

The filtration system shall consist of 2 stages of filtration mounted and plumbed to the air dryer. The first stage of filtration shall include a .01 micron coalescing pre-filter with element change indicator and automatic condensate drain and installed up-stream of the air dryer. The second stage shall include a 1 micron particulate filter with element change indicator and installed downstream of the air dryer. Activated carbon final filters are optional.

Dryer controls to include dryer alternating timer and slow acting automatic valves to open lag dryer for use based on dew point achieved. Each dryer is factory sized for flow with one compressor unit in reserve.

DEWPOINT MONITOR

The system-integrated hygrometer shall be equipped with an LCD dewpoint display and high dewpoint alarm with dry contacts connected to main controls panel. The sensor shall include an auto calibration feature to ensure the accuracy of the dewpoint measurement.

*NOTE: LDRE stands for Laboratory Duplex Rotary Screw Enclosure with Air Treatment Center Package, LTRE stands for Laboratory Triplex Rotary Screw Enclosure with Air Treatment Center Package



Duplex Laboratory Screw Compressor Enclosure (Air Cooled) and Air Treatment Center Package

Rev. 9/9/13

DIMENSIONS							
MODEL	DIM. A	DIM. B	DIM. B1	DIM. C	DIM. C1	DIM. D	Outlet
LDRE0406	99"	32"	67"	59"	95"	24"	2"
LDRE0507	59"	32"	70"	67"	79"	24"	2"
LDRE0607	57"	40"	70"	67"	63"	24"	2"
LDRE0757	57"	40"	70"	67"	63"	24"	2-1/2"
LDRE1007	57"	40"	70"	67"	77"	24"	2-1/2"

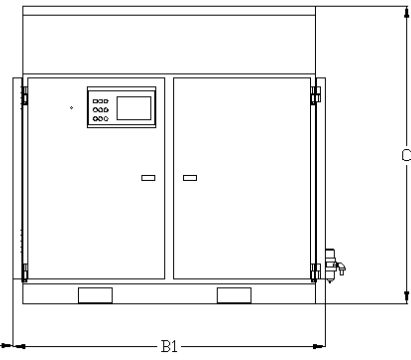
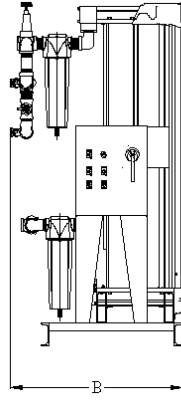
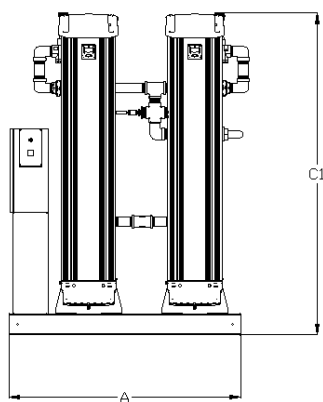
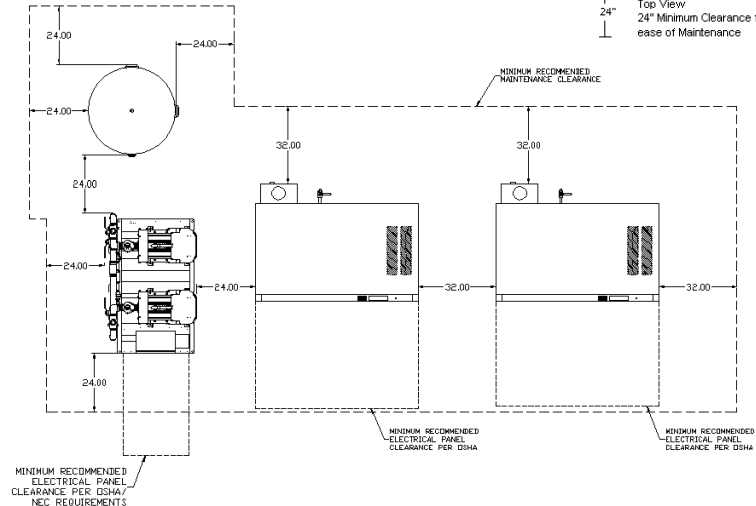
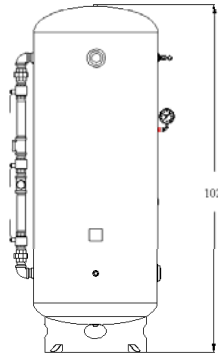
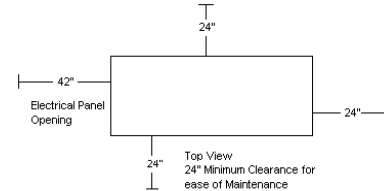

Duplex Laboratory Screw Enclosed Air Compressors (Air Cooled)										
with Air Treatment Center Package										
MODEL	HP	SCFM @ 125 PSIG ¹	Tank Size (Gal.)	BTU/Min. ²	dB(A) LEVEL ¹	RATED AMPS ²		Compressor Unit Wt. (Lbs.)	Tank Wt. (Lbs.) [*]	Dryer Package Wt. (Lbs.)
						230V	460V			
LDRE0406	40	244	240	1,930	70	156	78	2,480	-	1,624
LDRE0507	50	344	400	2,480	78	196	98	3,670	880	1,024
LDRE0607	60	446	400	3,030	78	228	114	3,740	880	1,182
LDRE0757	75	584	400	3,720	79	278	139	3,880	880	1,182
LDRE1007	100	800	400	5,280	81	354	177	3,910	880	1,544

Notes: 1- SCFM and dB(A) values are shown with all pumps running
 2 - BTU/Min. and Rated Amps are per compressor unit
^{*} 240 gal. tanks are skid mounted with ATC (Air Treatment Center); 400 gal. and larger tanks are shipped loose.



Duplex Laboratory Screw Compressor Enclosure (Water Cooled) and Air Treatment Center Package

Rev. 9/9/13

DIMENSIONS							
MODEL	DIM. A	DIM. B	DIM. B1	DIM. C	DIM. C1	DIM. D	Outlet
LDRE0406	99"	32"	67"	59"	95"	24"	2"
LDRE0507	59"	32"	70"	67"	79"	24"	2"
LDRE0607	57"	40"	70"	67"	63"	24"	2"
LDRE0757	57"	40"	70"	67"	63"	24"	2-1/2"
LDRE1007	57"	40"	70"	67"	77"	24"	2-1/2"

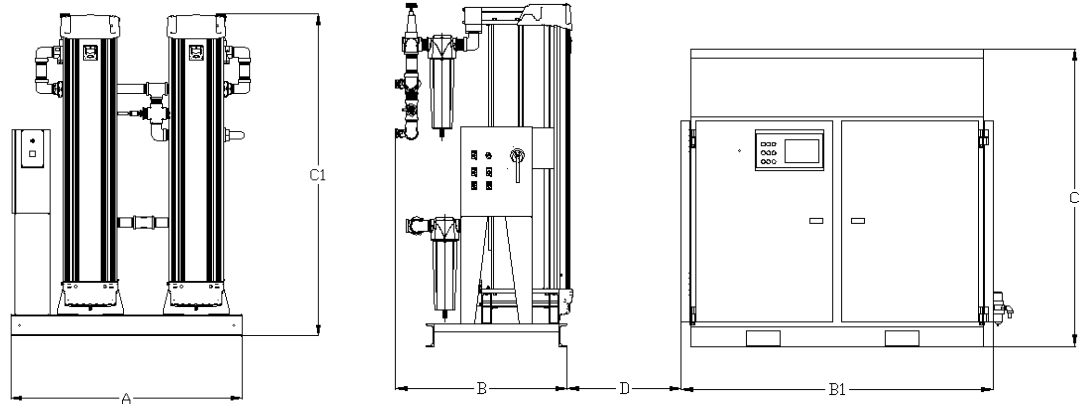
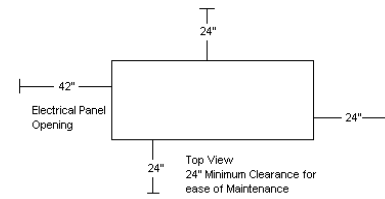
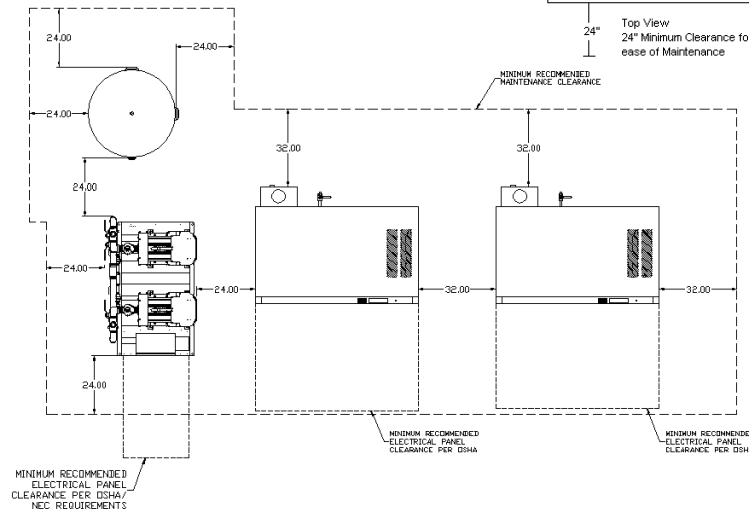
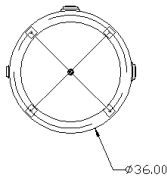
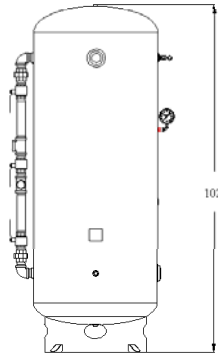

Duplex Laboratory Screw Enclosed Air Compressors (Water Cooled) with Air Treatment Center Package

MODEL	HP	SCFM @ 125 PSIG ¹	Tank Size (Gal.)	BTU/Min. ² To Water	BTU/Min. ² To Air	dB(A) LEVEL ¹	RATED AMPS ²		Compressor Unit Wt. (Lbs.)	Tank Wt. (Lbs.)*	Dryer Package Wt. (Lbs.)
							230V	460V			
LDRE0406	40	244	240	1,720	210	68	148	74	2,480	-	1,624
LDRE0507	50	344	400	2,340	260	74	188	94	3,670	880	1,024
LDRE0607	60	446	400	2,890	280	75	220	110	3,740	880	1,182
LDRE0757	75	584	400	3,620	290	75	272	136	3,880	880	1,182
LDRE1007	100	800	400	4,560	350	77	346	173	3,910	880	1,544

Notes: 1- SCFM and dB(A) values are shown with all pumps running
 2 - BTU/Min. and Rated Amps are per compressor unit
 * 240 gal. tanks are skid mounted with ATC (Air Treatment Center); 400 gal. and larger tanks are shipped loose.



Triplex Laboratory Screw Compressor Enclosure (Air Cooled) and Air Treatment Center Package

Rev. 9/9/13

DIMENSIONS							
MODEL	DIM. A	DIM. B	DIM. B1	DIM. C	DIM. C1	DIM. D	Outlet
LTRE0407	57"	40"	67"	59"	63"	24"	2"
LTRE0507	57"	40"	70"	67"	77"	24"	2"
LTRE0607	57"	45"	70"	67"	77"	24"	2-1/2"
LTRE0757	57"	45"	70"	67"	77"	24"	2-1/2"
LTRE1007	94"	40"	70"	67"	86"	24"	2-1/2"

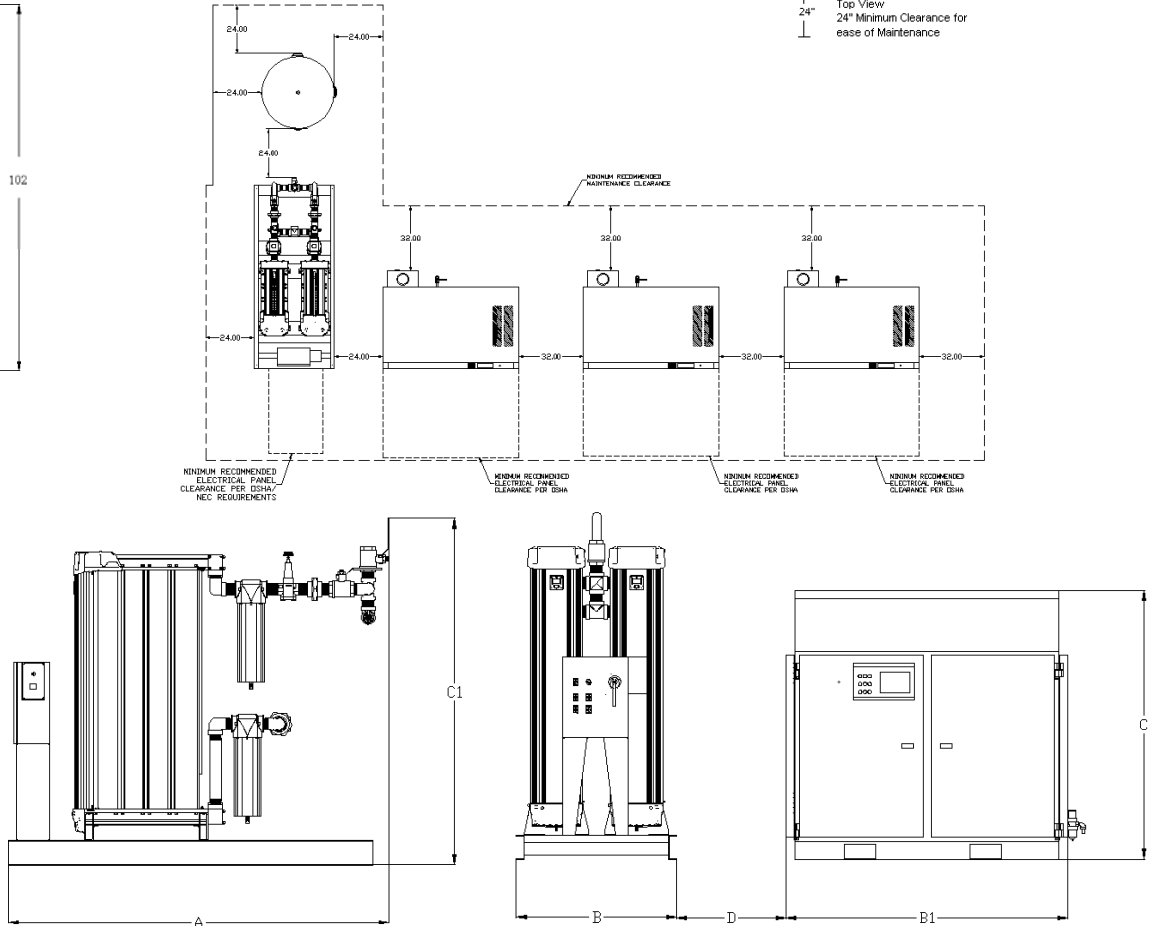
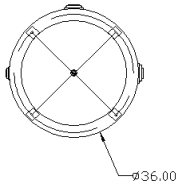
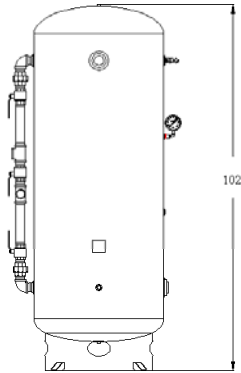
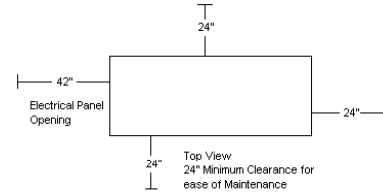

Triplex Laboratory Screw Enclosed Air Compressors (Air Cooled)										
with Air Treatment Center Package										
MODEL	HP	SCFM @ 125 PSIG ¹	Tank Size (Gal.)	BTU/Min. ²	dB(A) LEVEL ¹	RATED AMPS ²		Compressor Unit Wt. (Lbs.)	Tank Wt. (Lbs.)	Dryer Package Wt. (Lbs.)
						230V	460V			
LTRE0407	40	366	400	1,930	72	156	78	2,480	880	1,182
LTRE0507	50	516	400	2,480	80	196	98	3,670	880	1,544
LTRE0607	60	669	400	3,030	80	228	114	3,740	880	2,026
LTRE0757	75	876	400	3,720	81	278	139	3,880	880	2,026
LTRE1007	100	1200	400	5,280	83	354	177	3,910	880	2,470

Notes: 1- SCFM and dB(A) values are shown with all pumps running
2 - BTU/Min. and Rated Amps are per compressor unit



Triplex Laboratory Screw Compressor Enclosure (Water Cooled) and Air Treatment Center Package

Rev. 9/9/13

DIMENSIONS							
MODEL	DIM. A	DIM. B	DIM. B1	DIM. C	DIM. C1	DIM. D	Outlet
LTRE0407	57"	40"	67"	59"	63"	24"	2"
LTRE0507	57"	40"	70"	67"	77"	24"	2"
LTRE0607	57"	45"	70"	67"	77"	24"	2-1/2"
LTRE0757	57"	45"	70"	67"	77"	24"	2-1/2"
LTRE1007	94"	40"	70"	67"	86"	24"	2-1/2"

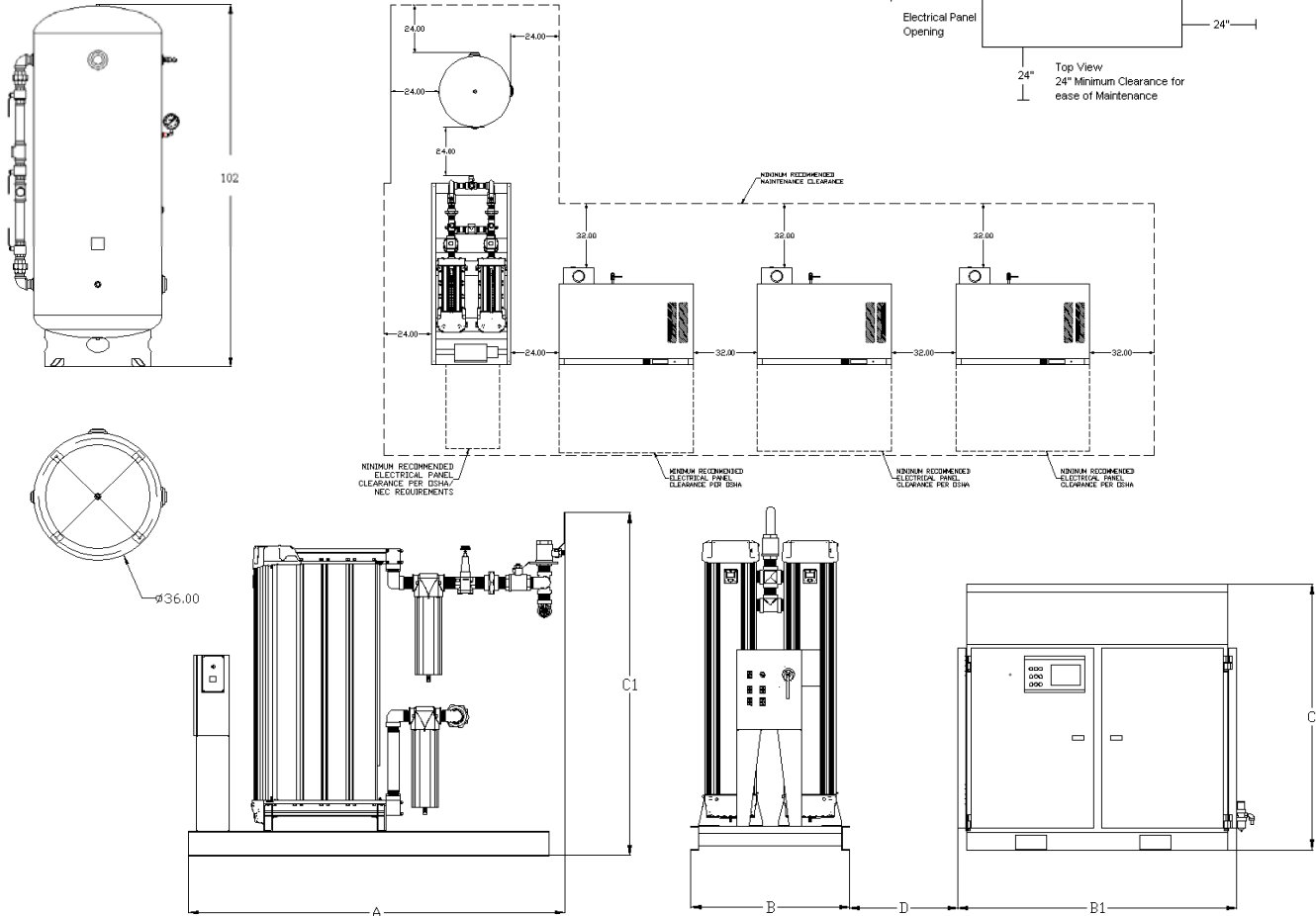

Triplex Laboratory Screw Enclosed Air Compressors (Water Cooled)												
with Air Treatment Center Package												
MODEL	HP	SCFM @ 125 PSIG ¹	Tank Size (Gal.)	BTU/Min. To Water ²	BTU/Min. To Air ²	dB(A) LEVEL ¹	RATED AMPS ²		Compressor Unit Wt. (Lbs.)	Tank Wt. (Lbs.)	Dryer Package Wt. (Lbs.)	
							230V	460V				
LTRE0407	40	366	400	1,720	210	70	148	74	2,480	880	1,182	
LTRE0507	50	516	400	2,340	260	76	188	94	3,670	880	1,544	
LTRE0607	60	669	400	2,890	280	77	220	110	3,740	880	2,026	
LTRE0757	75	876	400	3,620	290	77	272	136	3,880	880	2,026	
LTRE1007	100	1200	400	4,560	350	79	346	173	3,910	880	2,470	

Notes: 1- SCFM and dB(A) values are shown with all pumps running
 2 - BTU/Min. and Rated Amps are per compressor unit